

# KG AUTO

すぐれた品質を誇る「KG AUTO」のペンダントスイッチを、  
用途に応じて各種取り揃えました。

さまざまなメーカーのホイストクレーンに取り付けが可能です。











販売元 株式会社 北東電機

**kitatsuka denki**

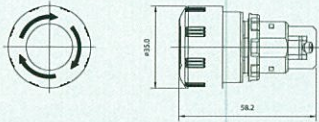

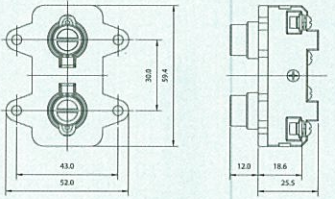
(KG-H10EPMHAAA)

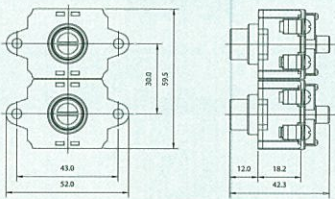
## 接点仕様及び外形図

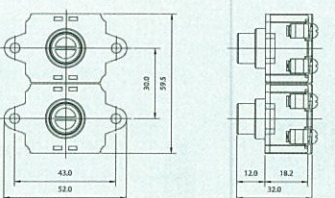
型番	接点ブロック	接点構成	定格	外形図
KG-HE100 (1b)			6A 250V	
KG-HA100 (1a-1a,1段)			6A 250V	
KG-HC100 (2a-2a,2段)			6A 250V	
KG-HT100 (2a-2a,1段)			6A 250V	

## 外形寸法

非常タイプ

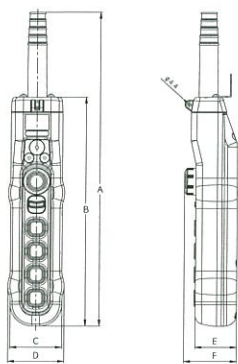

区分	A	B	C	D	E	F
H02EA (4 hole)	287.7	206.9	66.0	-	53.0	67.5
H04EAA (6 hole)	404.7	294.9	66.0	72.0	53.0	67.5
H06EAAA (8 hole)	464.7	354.9	66.0	72.0	53.0	67.5

一般タイプ

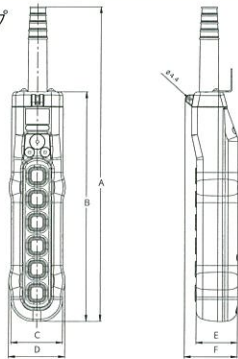

区分	A	B	C	D	E	F
H02A (2 hole)	227.7	146.9	66.0	-	53.0	67.9
H04AA (4 hole)	287.7	206.9	66.0	-	53.0	67.9
H06AAA (6 hole)	404.7	294.9	66.0	72.0	53.0	67.9
H08AAAA (8 hole)	464.7	354.9	66.0	72.0	53.0	67.9

## ホイスト用スイッチ製品及び外形図

ホイスト用スイッチ  
(KG-H10EPMHAAA)

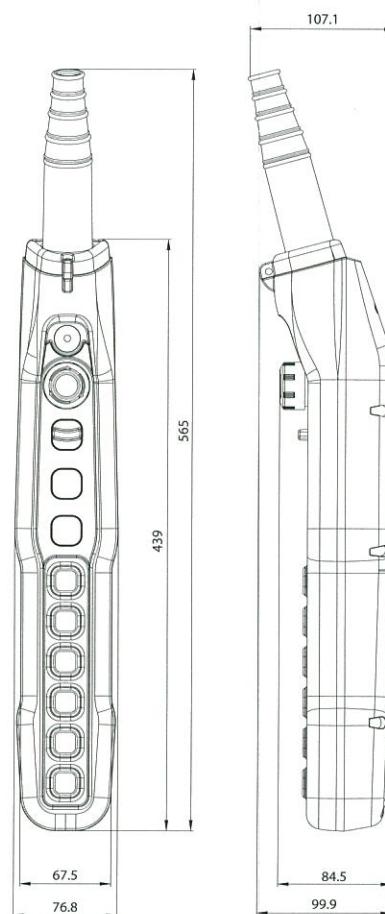
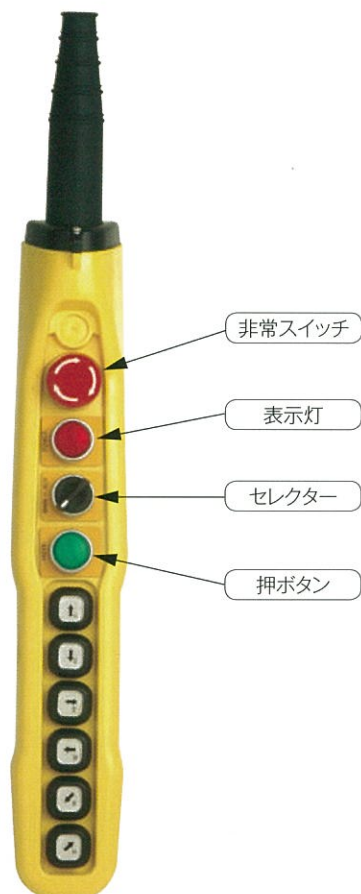

●お買い求め、ご相談は

販売元 /



株式会社 北東電機

**kitatsuka denki**

本社 / 広島県安芸郡海田町上市9-6

TEL (082) 209-8586 / FAX (082) 209-6407

ホームページ <http://kitatsuka.com/>

## 標準及び注文仕様



KG-H06EAAA



KG-H06EAAA



KG-H06ECAA



KG-H08AAAA

## ボリューム装着型注文仕様



KG-H02EA(1K)



KG-H04EAA(3K)



KG-H06EAAA(5K)

- 速度調節用ボリューム装着
- ネームプレートの種類
- ボリューム容量選択

※発注時に、銘板の用途を必ず表記ください。